

# MARIO

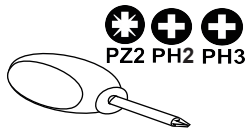

30min

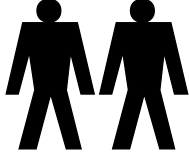

PZ2 PH2 PH3

**R**

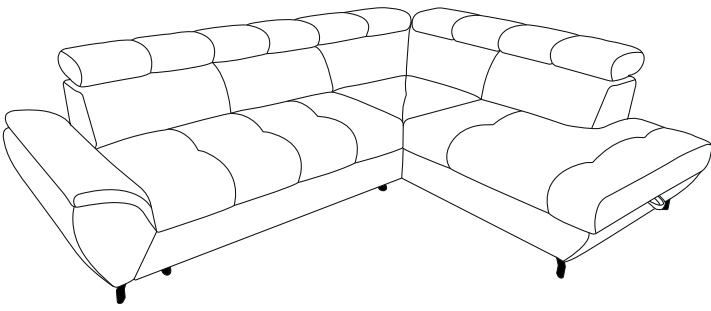

**L**

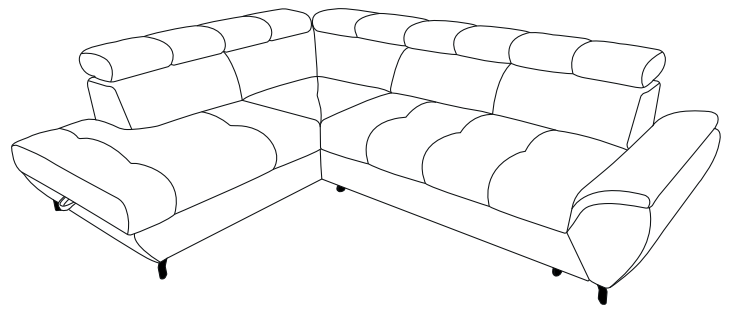

**I**

**R L**

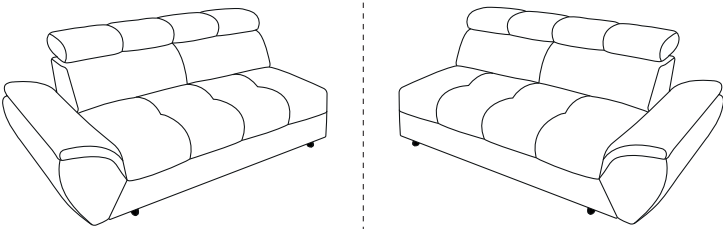

**II**

**R L**

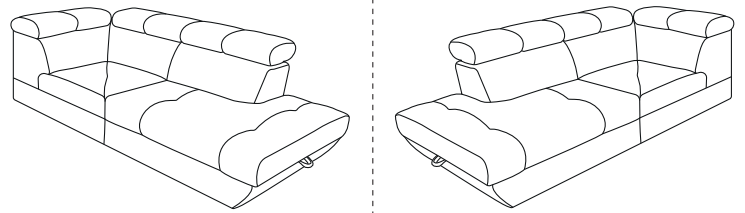

**Ax4**

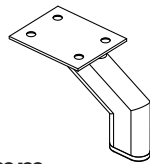

H=87 mm

**Bx3**

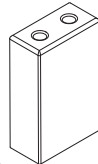

H=87 mm

**Cx1**

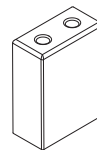

H=50 mm

**Dx12**

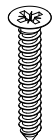

5x25



**Ex4**

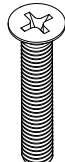

6x30



**Fx6**



5x80



**Gx2**

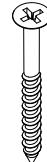

3,5x55



1

Ax2

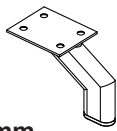

H=87 mm

Cx1

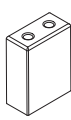

H=50 mm

Dx4



5x25

Ex4

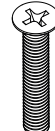

6x30

Gx2

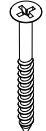

3,5x55

PH2

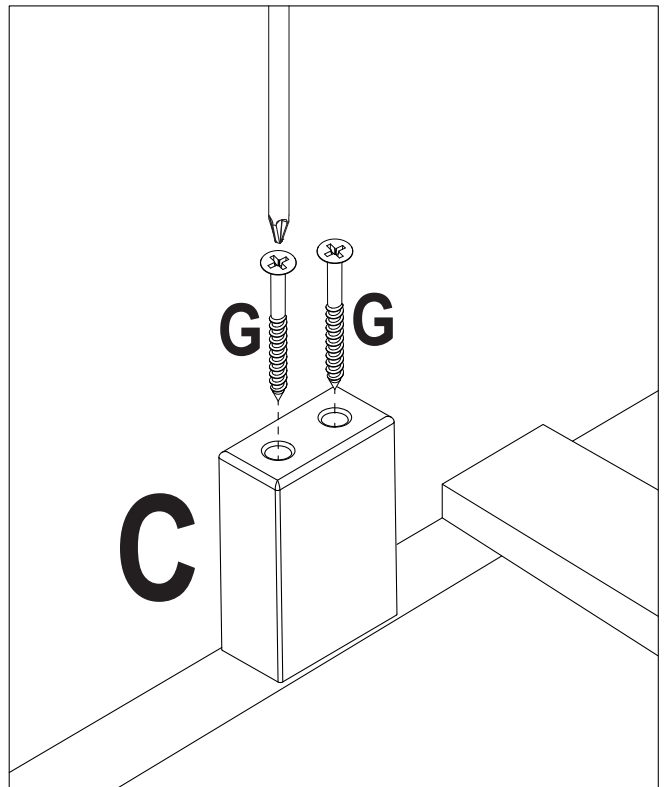
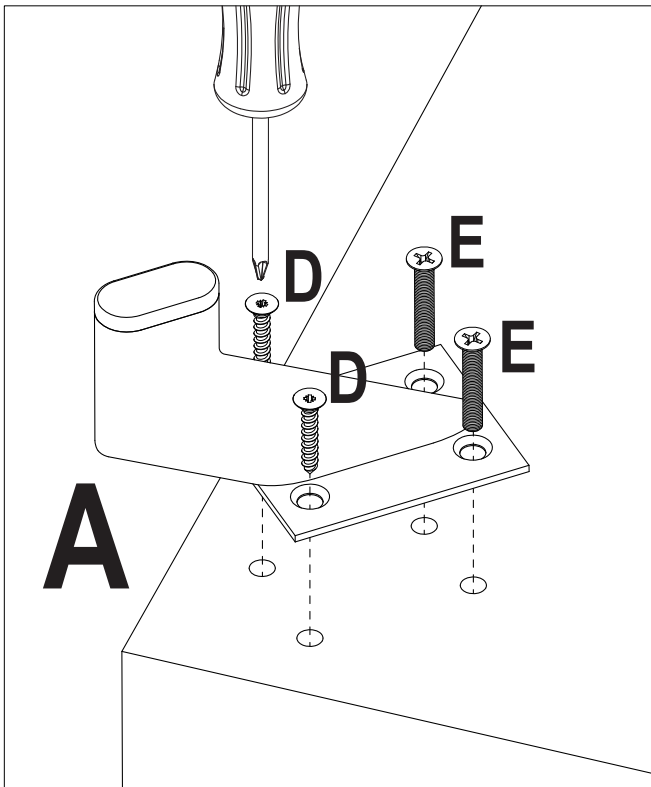
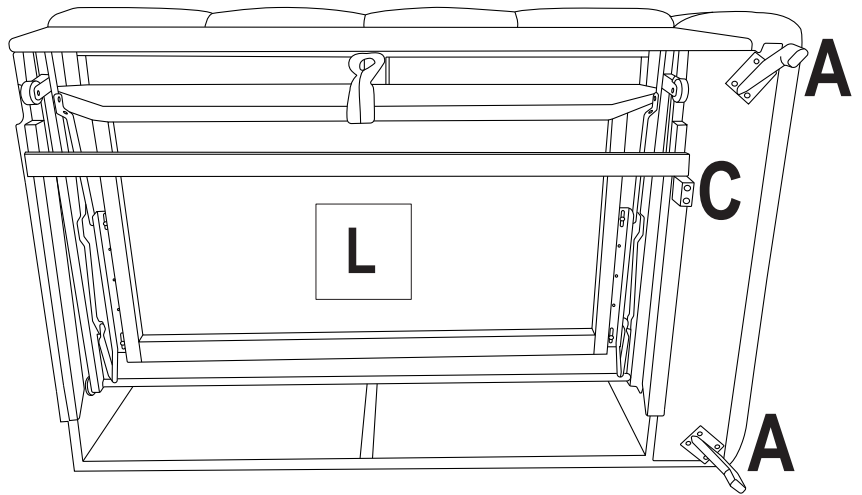
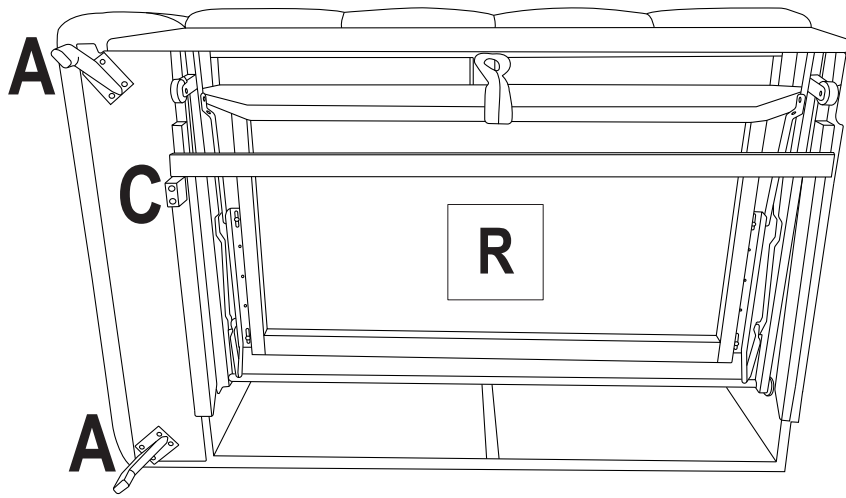

2

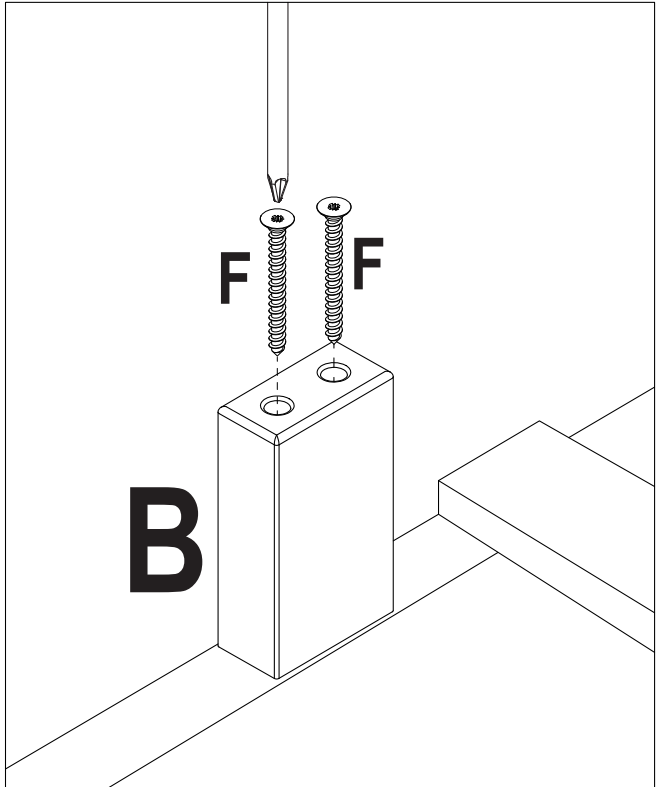
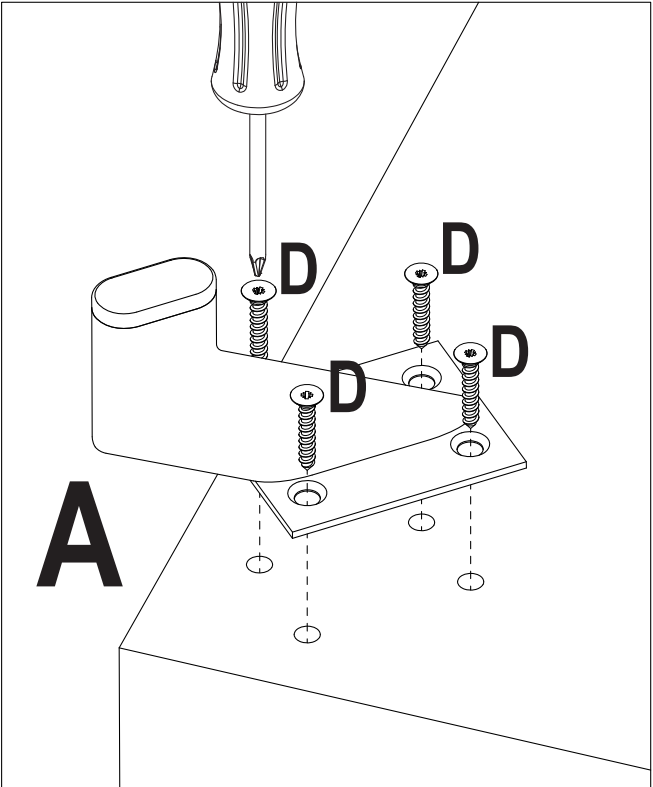
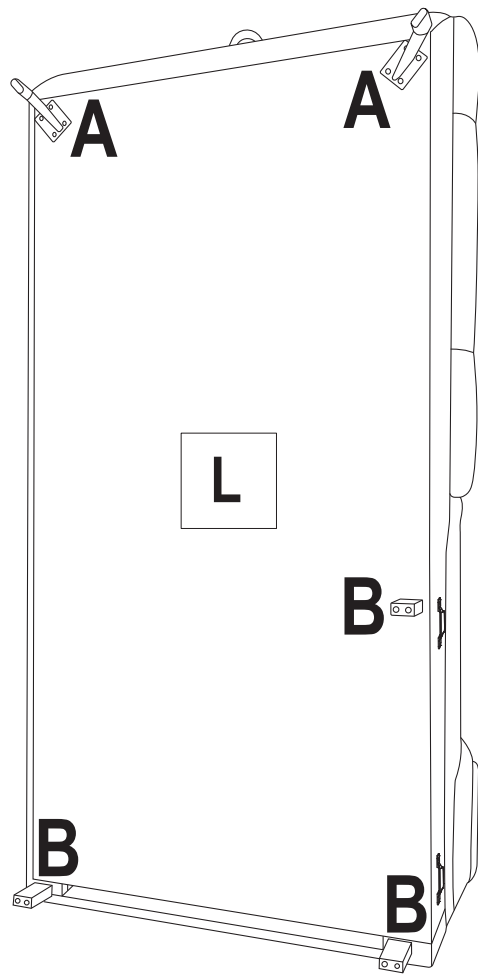
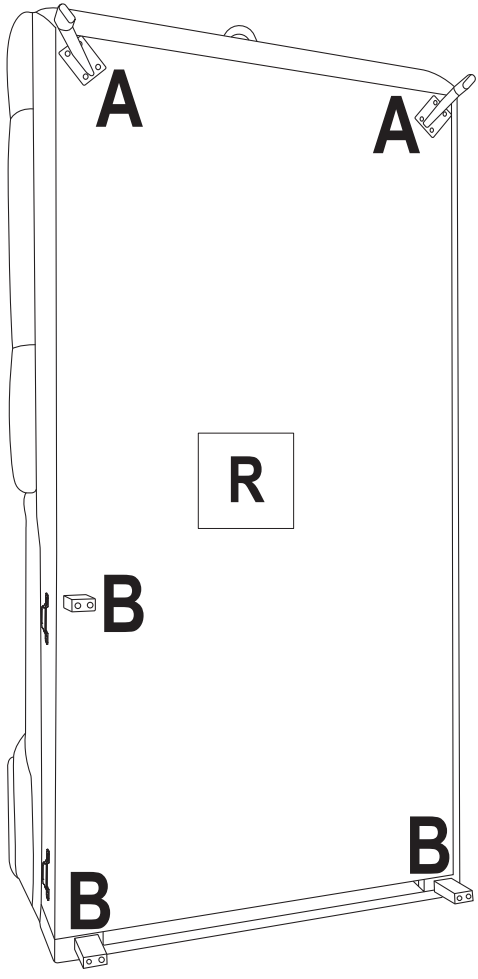
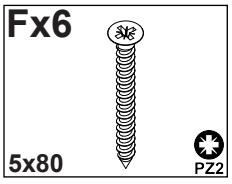
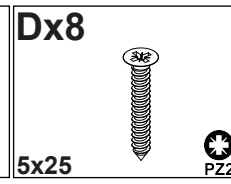
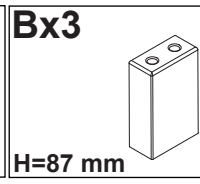
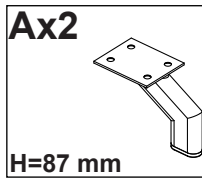

3

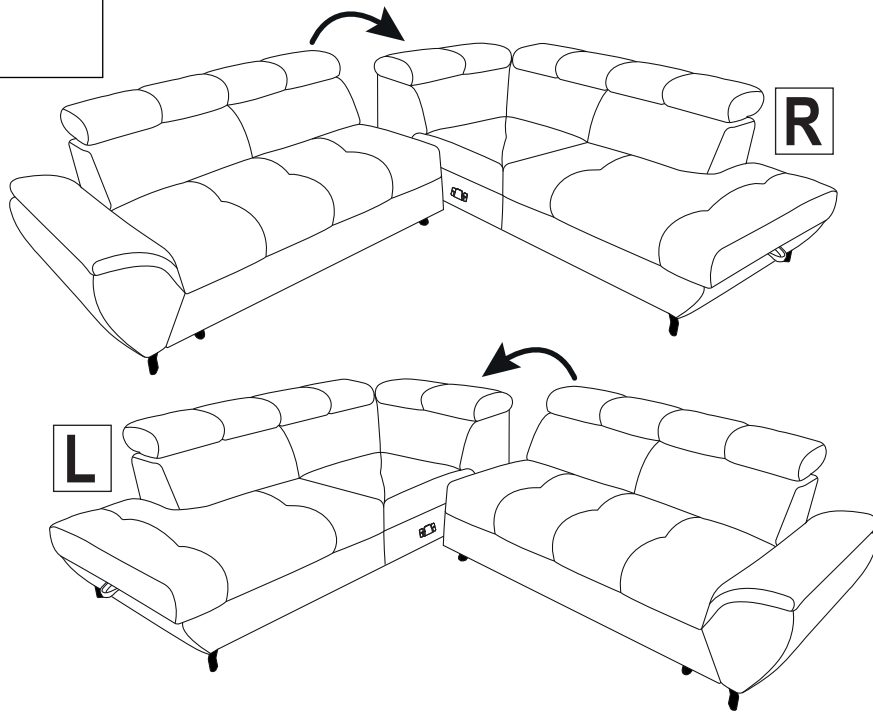

4

