

1.

# ME203\_08

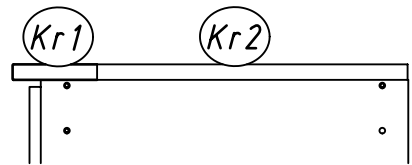

Typ I

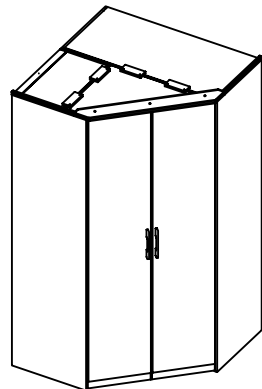
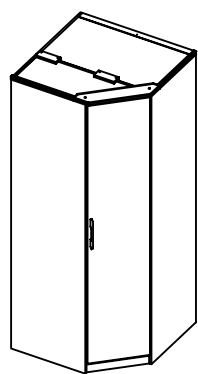
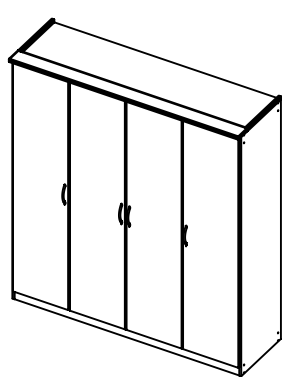

Typ II

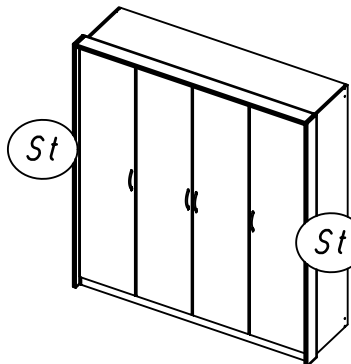
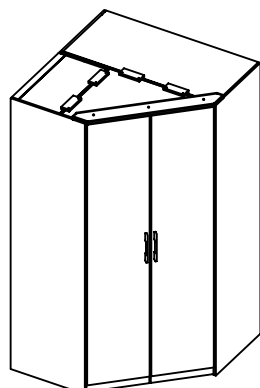
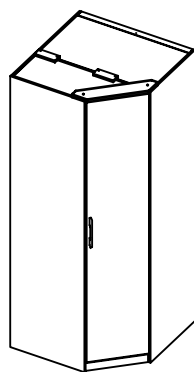
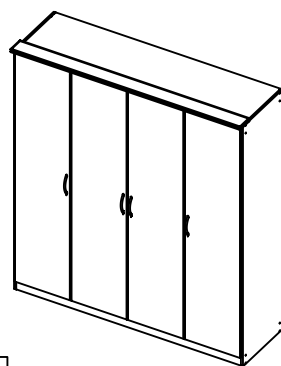

Typ III

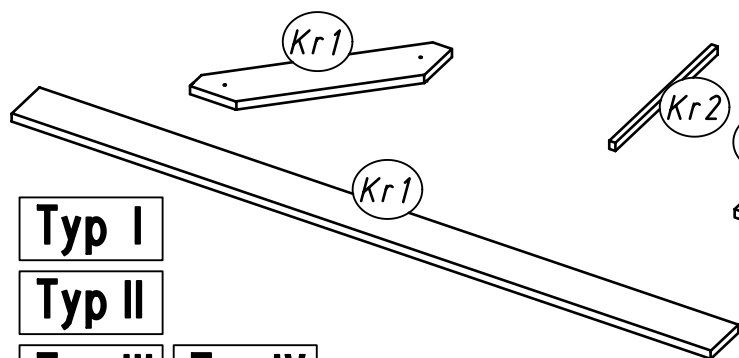

Typ I  
Typ II  
Typ III  
Typ IV

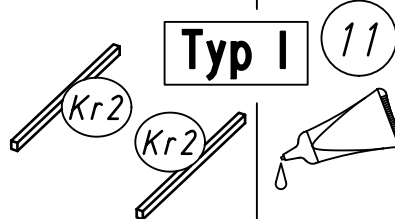

Typ I

11

174

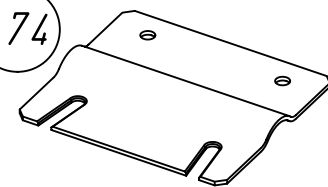
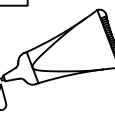

547

4x35

202

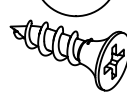

4.5x16

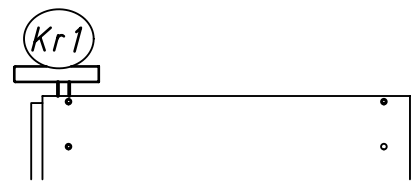

Typ IV

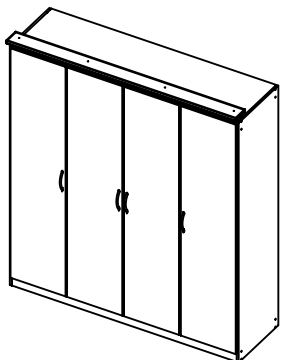

626

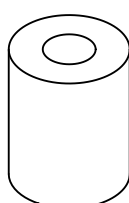

ø16x20

229

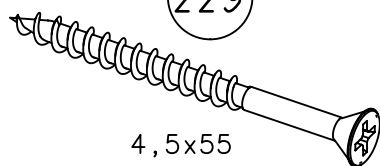

4,5x55

2.

1

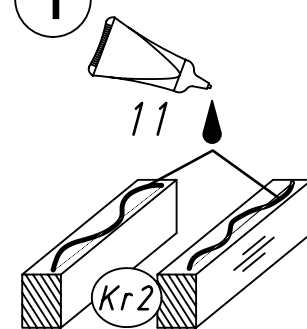

Typ I

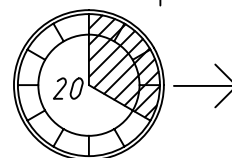
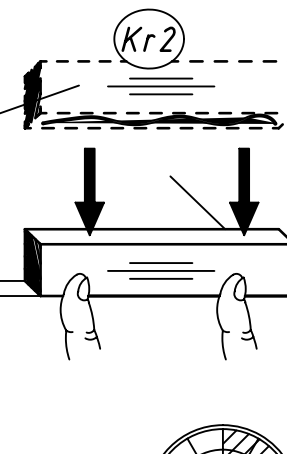
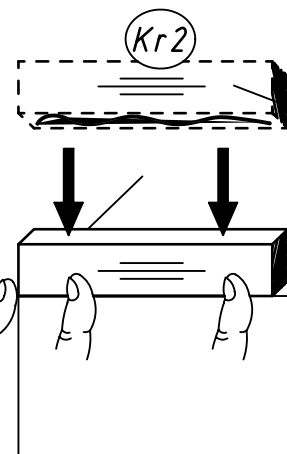

2

547

Typ I Typ II Typ III

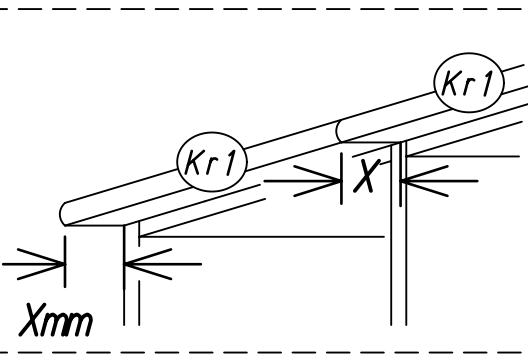
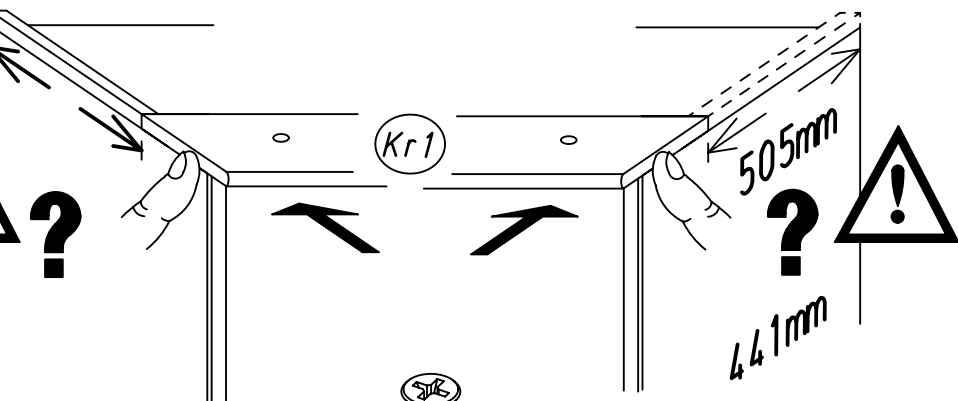
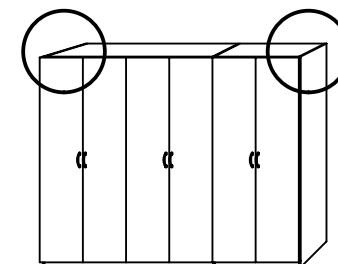

547

