

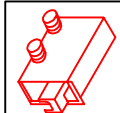







# KH 60, H 30, H 40, H 50, H 60

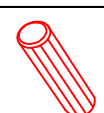
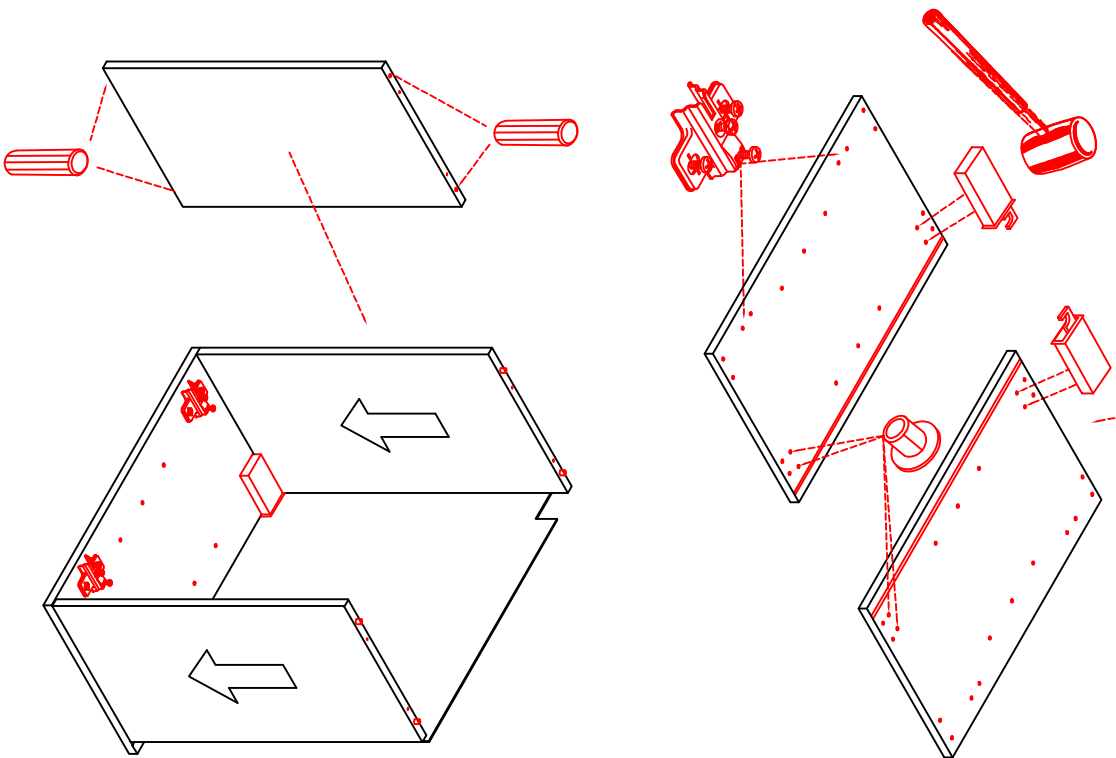
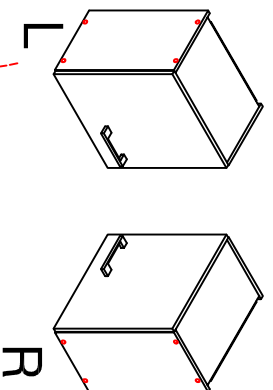

Montageanleitung / Notice de montage / Assembly instruction

- |    |  |
|----|--|
| 2x |        |
| 2x |       |
| 4x |  Ø 8mm |
| 8x |       |

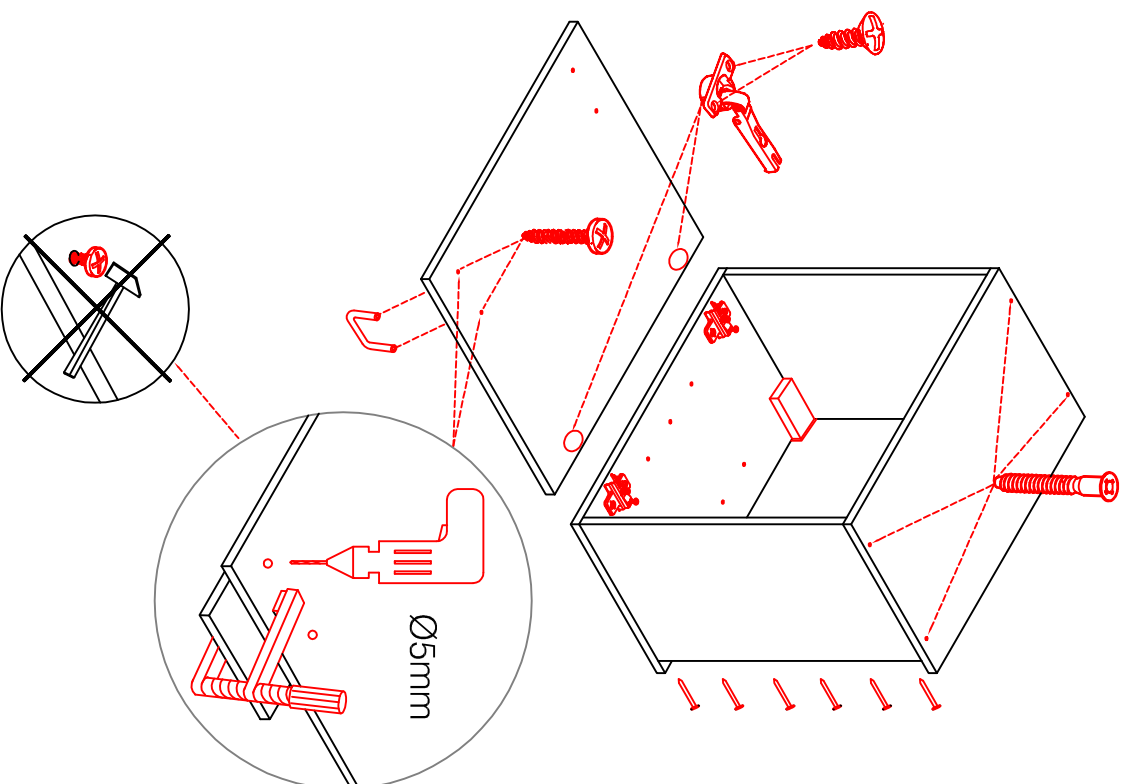

- |     |  |
|-----|--|
| 8x  |           |
| 25x |          |
| 2x  |         |
| 2x  |  4,0x30 |
| 1x  |         |
| 4x  |  3,5x15 |

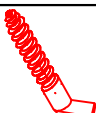

- |    |  |
|----|--|
| 4x |       |
| 2x |       |
| 2x |  Ø8mm |

